

# Cooling



Product competence from EUROPART

- Coolant cooler
- Coolant expansion tank
- Viscous fan
- Radiator fan coupling
- Water pumps
- Coolant thermostat
- Coolant hose/  
Charge air hose
- Cover lid
- Tools/Workshop requirements



## Introduction

### **A complex system for complex requirements.**

Modern cooling systems make a crucial contribution towards reducing emissions and consumption. Requirements for greater efficiency and profitability as well as factors such as higher payloads, turbocharger technology, auxiliary heaters and air conditioning systems, have resulted in classical engine cooling developing into a complex engine cooling system.

To meet the future stricter emission laws, the operating temperature must be increased by approx. 10%. Only in this way can optimised combustion be guaranteed. However, higher temperature also means greater cooling performance, so that the commercial diesel can complete its mileage with stability. Which is why quality spare parts are first choice for maintenance and repair.

The engine cooling system consists of various components. It is a sensitive system in which all components work under heat and pressure, like a well-trained team. In a new vehicle, all modules are one hundred percent coordinated with each other. Their performance and safety level can be retained through the use of quality spare parts. Technological expertise, performance design, fit and material quality are required.

### **What is Thermo Management?**

Thermo Management means achieving the optimal engine temperature in all operating conditions as well as heating and cooling of the passenger compartment. A modern Thermo Management System is therefore made up of components from the engine cooling system and components from the air conditioning system. Components from these two assemblies, which influence each other mutually, often form one unit.



## The coolant circuit

The engine cooling system has the task of cooling the engine by transferring heat to the outside air. At the same time, heat that can be used to heat the passenger compartment is created during operation of the engine. The engine cooling system and air conditioning system are two separate systems, yet they influence each other mutually.

The individual components of the coolant circuit are connected with each other by hose lines and thus form a closed system. The coolant circulates in the system, driven by a mechanical or electrical pump. The heat created during combustion of fuel and which then passes over the engine components, is transferred to the coolant.

Circulation causes the heat to be dissipated into the outside air and thus the coolant is cooled. One or more fans (mechanically or electrically driven), which can be accommodated in front of or behind the radiator, support the cooling process. In particular, this occurs when driving at slow speed or when the vehicle is stationary.

To keep the temperature of the coolant or engine relatively constant, the coolant flow is controlled by a thermostat.

- 1 Passenger compartment fan
- 2 Passenger compartment heat exchanger
- 3 Electrical heating valve
- 4 Coolant pump
- 5 Coolant control unit
- 6 Radiator fan
- 7 Coolant cooler
- 8 Case
- 9 Coolant temperature sensor
- 10 Oil cooler for hydrodynamic retarder

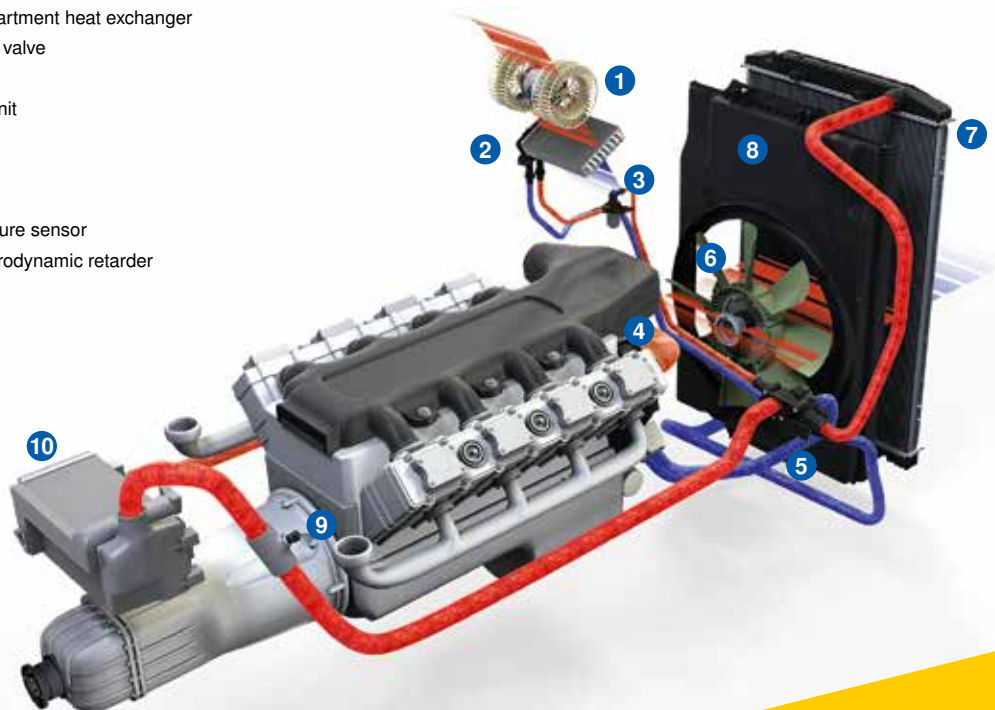

**EUROPART**  
GOOD TO KNOW

## Quality from BEHR, available from EUROPART.

With its recognised OEM expertise, BEHR has been producing genuine quality products for more than 100 years and thus offers maximum reliability in the use of cooling system products. BEHR components are perfectly coordinated with each other and achieve unrivalled cooling efficiency. They not only protect the engine against expensive damage through overheating – they also ensure the best possible performance, environmental compatibility and life of the engine. BEHR's many years of experience and extensive expertise guarantee the particular quality of all products.

Innovations are the basis of BEHR's success. The reason for this is the extensive research and development work that leads to innovative and high-quality products at BEHR. Already during product development, with the aid of state-of-the-art software, performance, reliability and quality are the deciding factors. This continues in the extensive tests under real conditions, which are carried out in the company's own testing and inspection facilities – such as engine test benches or the ultra-modern air conditioning wind tunnel.

With the most advanced production technologies company-wide, BEHR guarantees top quality in all products. So, for example, the precise development results in exact fit of all BEHR components. Extensive quality assurance systems also promise the durability and reliability of all products.

### Water tanks

- + The water tanks represent the gateway to the coolant cooler. Only high-quality materials guarantee a long service life here.
- Cheaper plastics are often used in cheap reproductions, which break more quickly and thus tend to leak.

### Seals

- + Seals are crucial to prevent a loss of coolant. Durable, resistant seals are always used in quality radiators.
- Poorly adjusted seals can lead to a loss of coolant as well as cracks in seals that have become brittle. Both can be the consequences of cost savings in production.

### Side plates and floor

- + A high-quality radiator also has a high-quality frame: All components in quality radiators guarantee a long service life and durability.
- Design weaknesses in cheap reproductions are often apparent not only in the material used, but also through the inadequate fit of the individual components.

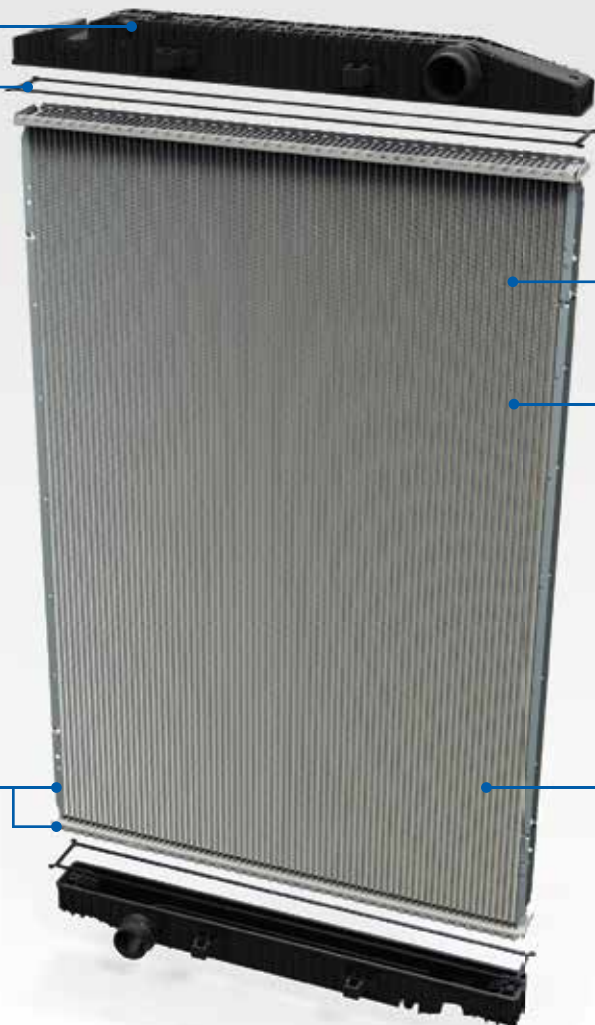

## Quality is irreplaceable. Except by new quality.

Not all radiators are the same. Cheap reproduction may appear to be a worthwhile alternative, but in actual fact, the complexity of the cooling systems used in modern engines can mean cheap reproductions are significantly different from OEM-quality radiators.

Sometimes with a dramatic impact:

Quality radiators have adequate power reserves in relation to flow rate and heat dissipation. They can, to a certain extent, compensate for ageing-related phenomena, such as reduced flow due to deposits or reduced efficiency due to contaminated surfaces. Cheap reproductions, on the other hand, often reach their performance limits significantly sooner. This is due to material savings or design flaws – for example, the turbulence inserts, which are not visible from the outside, and which are frequently installed in OEM quality radiators, may be missing.

In particular in “full-load operation” (e.g. at high load/tonnage and in hilly terrain), engines may overheat if cheap reproductions are used. The consequences range from vehicle breakdown due to a loss of coolant to major

engine damage – which in turn is associated with expensive repairs, unnecessary stationary times and high breakdown costs.

The use of “low quality” material can result in premature material fatigue (in the form of leaks due to cracks or even breakage of the water tank or radiator network). Unsuitable materials are also less resistant to salt water and corrode more quickly. If radiator fins break as a result, this will inevitably lead to worse heat dissipation and the associated risk of overheating.

### Flow and heat dissipation

- + Even ageing-related phenomena (such as reduced flow due to deposits or reduced efficiency due to contaminated surfaces) can, to a certain degree, be compensated for by quality radiators.
- Cheap reproductions often reach their performance limits significantly sooner. This is due to material savings and design flaws.

### Cooling ribs (network)

- + High-quality radiator grilles are characterised by corrosion and salt water-resistant materials and guarantee permanent, constant cooling performance.
- Inadequate salt water-resistance leads to corrosion more quickly and thus to a loss of radiator fins – which in turn causes reduced heat dissipation.

### Cooling pipes

- + To improve the cooling performance, spiral coils, wave-shaped bent strips, or other specially developed aluminium or plastic structures (so-called turbulence inserts) can be pushed into the pipes.
- Cheap reproductions rarely use turbulence inserts – which can significantly reduce their cooling performance.

## Coolant cooler

The most important component of the cooling module is the coolant cooler. It consists of a cooler block and a water tank with all required connections and mounting elements. The heat generated in the engine due to combustion is absorbed by the coolant and dissipated into the outside air via the radiator. Coolant coolers are installed in the air flow at the front of the vehicle.



This figure corresponds to 7501 503 071



### Engine radiator

Suitable for	Length x width x depth	Order no	Comparative no
DAF CF75, CF65	850 x 620 x 52 mm	7501 500 816	DAF 1627416
DAF CF85	950 x 620 x 52 mm	7501 501 098	DAF 1698298
DAF XF105	1067 x 748 x 40 mm	7501 510 811	DAF 1861737
DAF XF95, 95XF	1067 x 748 x 42 mm	7501 501 241	DAF 1326966
Mercedes-Benz Atego I/II	569 x 558 x 42 mm	7501 503 071	Mercedes-Benz 970 500 04 03
Mercedes-Benz New Actros, Actros I	952 x 808 x 40 mm	7501 521 731	Mercedes-Benz 942 500 11 03
Scania 94	860 x 686 x 42 mm	7501 504 111	Scania 1365371
Scania G, 114, 124, 144, 164	938 x 860 x 42 mm	7501 504 221	Scania 1327249
Scania R, G, P	998 x 860 x 40 mm	7501 511 941	Scania 0570485
Scania R, G, P	860 x 688 x 40 mm	7501 511 815	Scania 1784615
Volvo FH12, FM7, FM12	900 x 730 x 50 mm	7501 504 351	Volvo 1665249



### Engine radiator

Length 1020 mm  
Width 708 mm  
Depth 52 mm

Suitable for	Order no	Comparative no
Renault Magnum II/III	0376 728 711	Renault 5010619446



This figure corresponds to 9100 134 301



## Engine radiator

Suitable for	Length x width x depth	Order no	Comparative no
DAF XF105	1067 x 748 x 40 mm	0376 733 711	HELLA 8MK 376 733-711
Iveco Stralis II/III (Hi-Way), EuroStar	1124 x 748 x 42 mm	9100 400 007	HELLA 8MK 376 721-741
MAN F2000, E2000	945 x 708 x 40 mm	9100 260 571	HELLA 8MK 376 721-481
MAN F90	915 x 704 x 47 mm	9100 261 581	HELLA 8MK 376 709-561
MAN TGX, TGS, TGA	938 x 765 x 42 mm	9100 261 900	HELLA 8MK 376 721-711
MAN TGX, TGS, TGA	938 x 919 x 40 mm	9100 261 910	HELLA 8MK 376 721-681
MAN TGX, TGS, TGA, F2000	938 x 845 x 42 mm	0376 728 661	HELLA 8MK 376 728-661
Mercedes-Benz Actros I/MP2/MP3	1015 x 808 x 42 mm	9100 134 301	HELLA 8MK 376 721-491
Mercedes-Benz Actros I/MP2/MP3	902 x 808 x 42 mm	9100 132 081	HELLA 8MK 376 721-221
Mercedes-Benz Actros I/MP2/MP3	1015 x 808 x 52 mm	0376 756 151	HELLA 8MK 376 756-151
Mercedes-Benz Actros I/MP2/MP3, New Actros	952 x 808 x 40 mm	9100 132 101	HELLA 8MK 376 721-231
Mercedes-Benz Atego I/II	575 x 510 x 42 mm	9100 134 280	HELLA 8MK 376 758-021
Mercedes-Benz Atego I/II/III	569 x 558 x 42 mm	9100 134 180	HELLA 8MK 376 721-271
Mercedes-Benz Axor I/II/III	974 x 668 x 42 mm	0376 722 021	HELLA 8MK 376 722-021
Mercedes-Benz Axor I/II/III, Atego I, MK	815 x 668 x 42 mm	9100 139 720	HELLA 8MK 376 721-261
Mercedes-Benz SK, MK	810 x 638 x 42 mm	9100 132 431	HELLA 8MK 376 721-151
Renault Premium II	991 x 708 x 52 mm	0376 745 151	HELLA 8MK 376 745-151
Scania 164, 144, 124, 114, 94	938 x 860 x 42 mm	9100 270 070	HELLA 8MK 376 721-621
Scania 164, 144, 124, 114, 94	860 x 686 x 42 mm	8000 010 751	HELLA 8MK 376 724-611
Scania P, G, R, T	998 x 860 x 40 mm	9100 270 007	HELLA 8MK 376 745-741
Scania P, G, R, T	860 x 689 x 40 mm	3192 672 590	HELLA 8MK 376 756-171
Volvo FH II	900 x 699 x 48 mm	2860 065 466	HELLA 8MK 376 775-001



This figure corresponds to 0376 722 241



## Engine radiator

**Application range**  
for vehicles with manual gearbox

Suitable for	Length x width x depth	Order no	Comparative no
Fast Scolor IV MAN Lion's City (A20/A21/A23/A26/A37/A47/A78), NG (A23), NL (A21), NÜ (A20) Neoplan Centroliner (N 45XX) Solaris Urbino III	810 x 708 x 52 mm	0376 722 241	HELLA 8MK 376 722-241
Mercedes-Benz Citaro I/II/C2 (O 530), Conecto I (O 345) Setra S 315/319 NF, S 415 NF	1216 x 605 x 52 mm	9100 733 480	HELLA 8MK 376 792-101

## Coolant expansion tank

To avoid local overheating of the components, a bubble-free coolant circuit is required. The cooling medium enters the containers at high speed and exits again at low speed. For this reason, the nozzles have different diameters. Expansion tanks in commercial vehicles have three chambers and hold approx. 8 l water. The coolant expansion tank is used to hold expanded coolant from the coolant circuit. The pressure is released through a valve, allowing the system pressure to remain at a pre-set value.

A high coolant temperature results in a pressure increase in the cooling system, due to the expansion of the coolant. The coolant is pressed into the tank, which causes the pressure in the tank to rise. The opening pressure relief valve allows air to escape. During normalisation of the coolant temperature, a vacuum occurs in the cooling system.

As a result, the coolant is sucked out of the tank with the result that there is also a vacuum in the tank. The vacuum compensation valve in the sealing cap of the tank opens and air flows into the tank until pressure is equalised.



This figure corresponds to 1100 129 455



### Coolant expansion tank

Suitable for	Length x width x depth	Order no	Comparative no
DAF XF105	555 x 345 x 105 mm	6000 145 587	HELLA 8MA 376 731-621
DAF XF95	547 x 337 x 104 mm	9260 731 631	HELLA 8MA 376 731-631
Iveco Stralis I/II/III, Trakker III	589 x 460 x 180 mm	2591 215 631	HELLA 8MA 376 705-511
MAN E2000, F2000	743 x 321 x 108 mm	0376 705 331	HELLA 8MA 376 705-331
MAN F90	742 x 321 x 130 mm	9100 262 040	HELLA 8MA 376 705-241
MAN M2000M	742 x 321 x 130 mm	9990 000 406	HELLA 8MA 376 705-251
Mercedes-Benz Actros I/MP2/MP3	566 x 289 x 444 mm	9100 134 070	HELLA 8MA 376 705-081
Mercedes-Benz Actros MP2/MP3, Econic	566 x 289 x 444 mm	9100 133 130	HELLA 8MA 376 705-091
Mercedes-Benz Axor I/II/III, Atego I/II	651 x 228 x 194 mm	0376 705 361	HELLA 8MA 376 705-361
Mercedes-Benz LK, LN2	588 x 231 x 155 mm	9100 133 070	HELLA 8MA 376 705-301
Mercedes-Benz MK, SK, Actros	552 x 455 x 220 mm	9100 134 020	HELLA 8MA 376 705-201
Mercedes-Benz SK, MK, NG	552 x 455 x 220 mm	9100 134 010	HELLA 8MA 376 705-191
Scania 114	444 x 233 x 279 mm	1100 129 455	HELLA 8MA 376 705-461



This figure corresponds to 1221 900 884



## Coolant expansion tank

Suitable for	Length x width x height	Order no	Comparative no
DAF 85CF, 75CF, 65CF	610 x 450 x 270 mm	1221 900 893	DAF 1871493
DAF LF45 II Renault Midlum I/II Volvo FL II	619 x 146 x 381 mm	1221 900 925	DAF 1700772 Renault 7482582816 Volvo 20783901
DAF XF95	547 x 337 x 104 mm	1221 900 229	DAF 1684655
DAF XF95, 95XF	547 x 337 x 104 mm	1221 900 862	DAF 0393391
DAF XF105	555 x 345 x 105 mm	1221 900 863	DAF 1626237
Iveco EuroStar, EuroTech, EuroTrakker	420 x 310 x 170 mm	1221 900 225	Iveco 08168289
Iveco Stralis I/II, Trakker I/II	589 x 460 x 180 mm	1221 900 941	Iveco 41215631
MAN F90	742 x 321 x 130 mm	1221 900 892	MAN 81.06102-6099
MAN F2000	743 x 321 x 108 mm	1221 900 220	MAN 81.06102-6110
MAN F2000	743 x 321 x 142 mm	1221 900 224	MAN 81.06102-6117
MAN M2000M	742 x 321 x 130 mm	1221 900 891	MAN 81.06102-6089
Mercedes-Benz Actros I/MP2/MP3, Eonic	566 x 289 x 444 mm	1221 900 216	Mercedes-Benz 000 500 31 49
Mercedes-Benz Actros I/MP2/MP3	566 x 289 x 444 mm	1221 900 217	Mercedes-Benz 000 500 30 49
Mercedes-Benz Atego I/II	531 x 358 x 154 mm	1221 900 884	Mercedes-Benz 970 500 03 49
Mercedes-Benz Axor I/II, Atego I	651 x 228 x 194 mm	1221 900 294	Mercedes-Benz 906 200 11 22
Mercedes-Benz LK/LN2	588 x 231 x 155 mm	1221 900 856	Mercedes-Benz 673 500 01 49
Mercedes-Benz OM 457	800 x 325 x 82 mm	1221 900 223	Mercedes-Benz 627 500 00 49
Mercedes-Benz SK, MK	552 x 455 x 220 mm	1221 900 226	Mercedes-Benz 000 500 22 49
Mercedes-Benz SK, MK	552 x 455 x 220 mm	1221 900 228	Mercedes-Benz 000 500 21 49
Renault Premium II, Midlum II Volvo FE	470 x 310 x 155 mm	1221 900 871	Renault 5010141465
Scania 114	444 x 233 x 279 mm	1221 900 214	Scania 1370707
Volvo FH12, FH16	329 x 289 x 145 mm	1221 900 215	Volvo 1676400
Volvo FH12, FM12	560 x 290 x 180 mm	1221 900 221	Volvo 1674918



This figure corresponds to 1221 900 218



### Coolant expansion tank

Suitable for	Length x width x height	Order no	Comparative no
<b>Mercedes-Benz</b> Citaro I (O 530), Conecto I (O 345)	566 x 289 x 444 mm	<b>1221 900 218</b>	Mercedes-Benz 000 500 35 49
<b>MAN</b> Lion's City (A21), Lion's Classic Ü (A72), Lion's Classic (A74), EL (A12), NG (A11), NL (A10/A15/A21), HOCL	860 x 227 x 80 mm	<b>1221 900 222</b>	MAN 81.06102-6118



### Coolant expansion tank

Length 566 mm  
 Width 289 mm  
 Height 444 mm  
 Volume 12,2 l

Suitable for	Order no	Comparative no
<b>Mercedes-Benz</b> Citaro I/II/C2 (O 530), Conecto I (O 345) <b>Setra</b> S 415 NF	<b>0376 705 472</b>	HELLA 8MA 376 705-471

# Viscous fan



To dissipate heat in commercial vehicle engines, fans and fan drives, which provide cool air particularly efficiently, are required in addition to powerful radiators. Fans consist of a fan wheel and a coupling. They are used with longitudinal engines and are installed in the direction of travel in front of the radiator.



**EURO PART**



## Fan wheel

∅ 654 mm  
Number of blades 8

Suitable for	Order no	Comparative no
MAN TGM, TGL, F2000, M2000M/L, L2000, M90	1888 702 001	MAN 51.06601-0258



## Fan wheel

Suitable for	Outer ∅	Number of blades	Order no	Comparative no
Mercedes-Benz Actros I/MP2/MP3	750 mm	8	9100 139 790	Mercedes-Benz 003 205 01 06
Scania R, G, P	752 mm	11	5831 853 555	Scania 1853555



This figure corresponds to 0376 733 181

## Fan wheel

Suitable for	Outer ∅	Number of blades	Order no	Comparative no
Iveco Stralis II AD	654 mm	8	0376 733 101	HELLA 8MV 376 733-101
MAN TGX, TGS, TGA	754 mm	9	0376 728 111	HELLA 8MV 376 757-721
Mercedes-Benz Atego II	704 mm	8	0376 733 181	HELLA 8MV 376 733-181
Mercedes-Benz Axor II, Atego I/II	600 mm	8	0376 757 741	HELLA 8MV 376 757-741
Scania R, G, P	752 mm	11	5831 853 555	HELLA 8MV 376 791-641

# Radiator fan coupling

The radiator fan coupling establishes the positive-locking connection with the fan wheel based on the temperature, and influences its speed. The drive torque is transferred to the fan wheel via a non-wearing liquid friction, and the speed is set infinitely variably via the operating conditions. The electrically actuated viscous coupling is regulated directly via sensors. Demand-based cooling optimises the coolant temperature level, engine noise and fuel consumption.

## Overview of the production process for EUROPART viscous couplings



### Design phase

Design is the first stage of the development process of EUROPART viscous couplings. In this phase, the individual components, which make up the viscous coupling, are designed such that the final product meets the desired objective. To this end, professional 3D modelling software is used.



### Steel casting and machining phase

At the end of the design phase, all finished components of the viscous coupling are available. The coupling essentially consists of two parts: The housing, which is first produced from injection moulded aluminium and is then machined to achieve the required production tolerances, and the machined steel input shaft.



### Raw material inspection phase

After the steel casting and machining phase, a strict and comprehensive quality control of all components is carried out to guarantee proper production and correct function of the final product. The material inspection is carried out mechanically, including by automatic coordinate measuring machines.



### Production and assembly phase

After the individual components have passed the quality inspection, the assembly phase begins for the coupling components. Machines that have been specially developed for the assembly of viscous coupling components are used. This allows for optimal control of the production process and means the consistency of all produced coupling can be guaranteed.



### Testing phase on test benches

After complete assembly, the functional inspection is carried out to guarantee that the product meets the strict requirements for which it was developed. The inspection includes the temperature-dependent positive-locking connection to the fan wheel and the resulting infinitely variable speed control. Each reference runs through a specific test, depending on the brand and model.

**EUROPART**  
GOOD TO KNOW



This figure corresponds to  
1888 000 049 

## Radiator fan coupling

Suitable for	∅	Version	Order no	Comparative no
DAF XF105, CF85	275 mm	electrical	1888 734 781	DAF 1742083
DAF XF95	233 mm	electronic	1888 000 033	DAF 1427573
DAF XF95, 95XF, 95	203 mm	thermal	1888 000 029	DAF 1334257
MAN F 2000	203 mm	thermal	1888 000 044	MAN 51.06630-0066
MAN F2000, E2000, F90	290 mm	pneumatic	1888 000 052	MAN 51.06630-0068
MAN TGA	190 mm	electrical	1888 000 046	MAN 51.06630-0076
MAN TGA	236 mm	electrical	1888 000 047	MAN 51.06630-0077
MAN TGA, TGS	245 mm	electrical	1888 000 049	MAN 51.06630-0096
MAN TGX, TGS, TGA	270 mm	electrical	1888 757 231	MAN 51.06630-0140
MAN TGX (2007-), TGS, TGA	205 mm	electrical	1888 000 050	MAN 51.06630-0131
Mercedes-Benz Actros I/MP2/MP3, MK, SK	233 mm	thermal	1888 000 016	Mercedes-Benz 000 200 81 22
Mercedes-Benz Actros MP2/MP3	246 mm	electrical	1888 000 025	Mercedes-Benz 541 200 18 22
Mercedes-Benz Actros MP2/MP3, Atego I/II	240 mm	electrical	1888 000 026	Mercedes-Benz 000 200 85 22
Mercedes-Benz Axor I, Atego I/II/III, Unimog	203 mm	thermal	1888 000 021	Mercedes-Benz 906 200 08 22
Renault Premium II, Kerax	260 mm	electrical	1888 000 005	Renault 7420880406
Scania R, G, P	750 mm	electrical	1888 000 064	Scania 1856995
Scania R, P, G	270 mm	mechanical	1888 035 611	Scania 2035611
Volvo FH12, FH16, NH12, FL12	750 mm	Thermal	1888 000 068	Volvo 1674189
Volvo FH II (2005-)	750 mm	electric	1888 000 065	Volvo 85000818



This figure corresponds to 0376 757 461 

## Radiator fan coupling

Suitable for	Version	∅	Order no	Comparative no
DAF 95XF	electronic	233 mm	6001 427 573	HELLA 8MV 376 730-051
DAF XF105, CF85	electronic	275 mm	0376 734 781	HELLA 8MV 376 734-781
DAF XF105, CF85 II	electronic	275 mm	0376 734 211	HELLA 8MV 376 734-211
DAF XF95, 95XF	thermal	203 mm	9100 298 260	HELLA 8MV 376 731-341
MAN E2000, F2000	electronic	190 mm	0376 758 471	HELLA 8MV 376 758-471
MAN F2000	thermal	203 mm	9100 268 270	HELLA 8MV 376 731-281
MAN TGA	electronic	245 mm	0376 757 661	HELLA 8MV 376 757-661
MAN TGA, F2000	electronic	236 mm	0376 758 511	HELLA 8MV 376 758-511
Mercedes-Benz Actros I/MP2	thermal	233 mm	0376 730 061	HELLA 8MV 376 730-061
Mercedes-Benz Actros MP2/MP3, Arocs	electronic	260 mm	0376 757 461	HELLA 8MV 376 757-461
Mercedes-Benz Atego I/II	thermal	203 mm	0376 731 362	HELLA 8MV 376 731-361
Mercedes-Benz Atego II	thermal	203 mm	0376 731 351	HELLA 8MV 376 731-351
Renault Premium II	electronic	260 mm	0376 757 121	HELLA 8MV 376 757-121
Scania 164	electronic	750 mm	0376 729 431	HELLA 8MV 376 729-431
Scania R, G, P, T	electronic	750 mm	0376 734 321	HELLA 8MV 376 734-321
Volvo FH16	electronic	750 mm	0376 730 081	HELLA 8MV 376 730-081
Volvo FH II (2002-), FH12	electronic	750 mm	0376 731 481	HELLA 8MV 376 731-481

## Water pumps

The water pump is driven mechanically, delivers the coolant through the circuit and establishes system pressure. Usually the water pump is connected to the drive by belts.



### Structure of a water pump

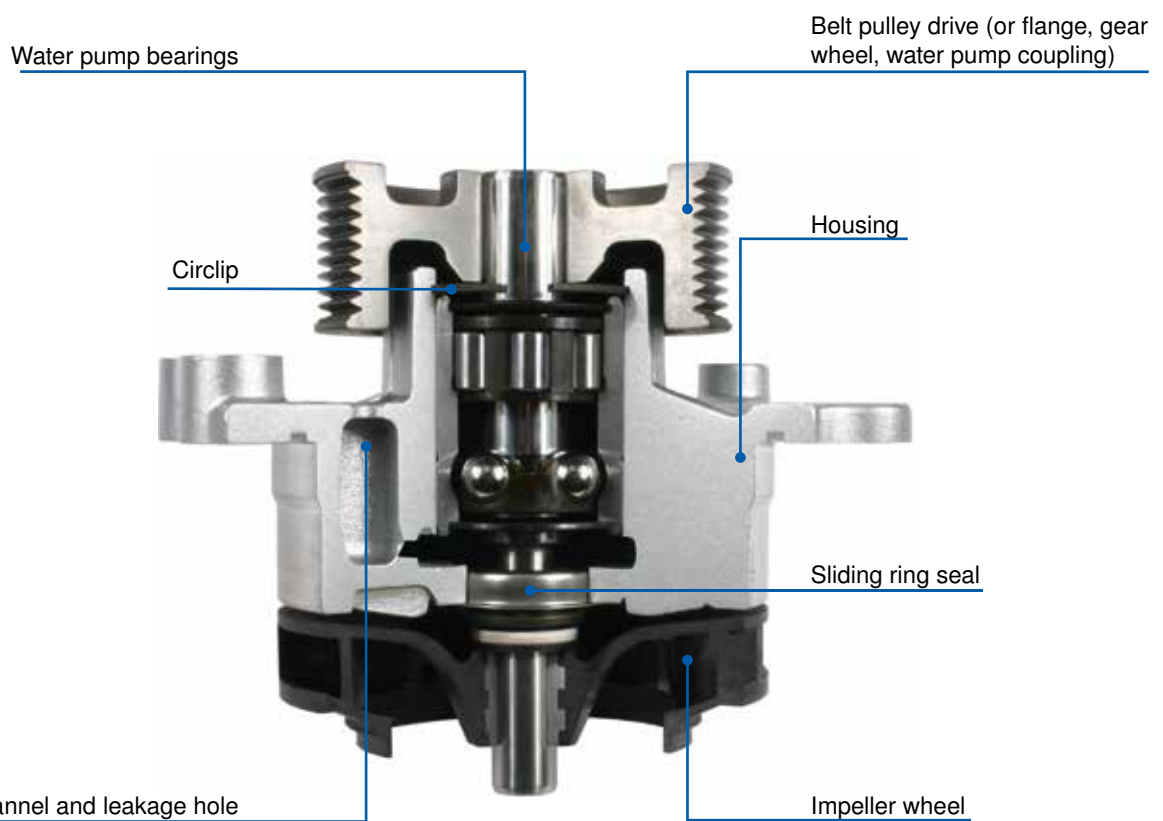

**EUROPART**  
GOOD TO KNOW



This figure corresponds to 9150 000 970



## Water pump

Scope of supply  
with gaskets

Suitable for	Impeller- $\varnothing$	Order no	Comparative no
DAF 65CF, CF65, LF45, LF55 Iveco EuroCargo II, EuroFire	83 mm	9150 000 904	DAF 1399689 Iveco 504062854
DAF 95XF, XF95, 85CF, 75CF, LF45	135 mm	9150 000 978	DAF 683586
DAF CF85, XF95	135 mm	9150 000 920	DAF 682980
DAF CF85, XF95	135 mm	9150 000 964	DAF 682968
DAF F75, F85, F95	110 mm	9150 000 919	DAF 680217 DAF 682263
DAF XF105, XF95, CF85	120 mm	9150 000 931	DAF 1828162
DAF XF95, 95XF, CF85, 85CF	135 mm	9150 000 911	DAF 1399336
Iveco EuroCargo I	96 mm	9150 000 975	Iveco 98415831
Iveco Stralis I/II, EuroStar, EuroTech, EuroTrakker, Trakker I/II	120 mm	9150 000 916	Iveco 500356553
MAN F2000, F90	135 mm	9150 000 944	MAN 51.06500-6492
MAN F2000, F90	135 mm	9150 000 947	MAN 51.06500-6492
MAN F2000, F90, M90	135 mm	9150 000 965	MAN 51.06500-6547
MAN F2000, L2000, M2000L, M90	135 mm	9150 000 936	MAN 51.06500-3178
MAN F2000, L2000, M2000L/M, M90	125 mm	9150 000 939	MAN 51.06500-6462
MAN F90 Mercedes-Benz SK, MK, NG	135 mm	9150 000 935	Mercedes-Benz 403 200 75 01
MAN G90	110 mm	9150 000 948	MAN 51.06500-6443
MAN G90	110 mm	9150 000 949	MAN 51.06500-6432
MAN L2000, M2000L/M, M90	125 mm	9150 000 955	MAN 51.06500-6537
MAN M2000L/M, L2000	110 mm	9150 000 900	MAN 51.06500-6515
MAN M2000L/M, L2000, M90	125 mm	9150 000 962	MAN 51.06500-6612
MAN TGA, E2000, F2000	135 mm	9150 000 966	MAN 51.06500-6546
MAN TGA, F2000	209 mm	9150 000 917	MAN 51.06500-7089
MAN TGA, F2000, F90	135 mm	9150 000 958	MAN 51.06500-6426
MAN TGA, TGL, TGM, M2000L	135 mm	9150 000 932	MAN 51.06500-6679
MAN TGL, TGM	136 mm	9150 000 930	MAN 51.06500-6587
MAN TGM, TGL	135 mm	9150 000 933	MAN 51.06500-6680
MAN TGX, TGS, TGA	135 mm	9072 201 081	MAN 51.06500-6637
MAN TGX, TGS, TGA, M2000, L2000, M90	135 mm	9150 000 971	MAN 51.06500-6675
Mercedes-Benz Actros I/MP2/MP3	125 mm	9150 000 902	Mercedes-Benz 542 200 18 01
Mercedes-Benz Actros I/MP2/MP3	125 mm	9150 000 972	Mercedes-Benz 542 200 20 01
Mercedes-Benz Actros I/MP2/MP3	125 mm	9072 201 072	Mercedes-Benz 541 200 10 01
Mercedes-Benz Actros MP2/MP3	125 mm	9150 000 918	Mercedes-Benz 541 200 12 01
Mercedes-Benz Axor, Eonic	125 mm	9150 000 909	Mercedes-Benz 457 200 24 01
Mercedes-Benz Axor I/II	125 mm	9150 000 973	MAN 51.06501-3143
Mercedes-Benz Axor I/II	125 mm	9150 000 974	Mercedes-Benz 457 200 29 01
Mercedes-Benz Axor I/II, Atego I/II, Eonic, LK/LN2, Unimog	112 mm	9150 000 967	Mercedes-Benz 904 200 49 01

Continued on the next page ...

... continued from the previous page

Suitable for	Impeller-∅	Order no	Comparative no
<b>Mercedes-Benz</b> Axor I/II/III, Atego I/II/III, Econic, Unimog (U300/400), Zetros	112 mm	<b>9150 000 970</b>	Mercedes-Benz 906 200 65 01
<b>Mercedes-Benz</b> Axor II, Atego I/II/III, Unimog	112 mm	<b>9150 000 921</b>	Mercedes-Benz 904 200 51 01
<b>Mercedes-Benz</b> LK/LN2, MK, NG	94,5 mm	<b>9150 000 952</b>	Mercedes-Benz 366 200 59 01
<b>Mercedes-Benz</b> LK/LN2, T2/LN1, Unimog (U110/130/140)	94,5 mm	<b>9150 000 954</b>	Mercedes-Benz 364 200 20 01
<b>Mercedes-Benz</b> LP, NG, Unimog	94,5 mm	<b>9150 000 941</b>	Mercedes-Benz 353 200 56 01
<b>Mercedes-Benz</b> LP, Unimog	94,5 mm	<b>9150 000 951</b>	Mercedes-Benz 314 200 41 01
<b>Mercedes-Benz</b> MK, NG	125 mm	<b>9150 000 934</b>	Mercedes-Benz 422 200 13 01
<b>Mercedes-Benz</b> MK, Unimog	94,5 mm	<b>9150 000 953</b>	Mercedes-Benz 366 200 05 01
<b>Mercedes-Benz</b> SK, MK, NG	125 mm	<b>9150 000 940</b>	MAN 51.06500-6282
<b>Mercedes-Benz</b> Unimog	94,5 mm	<b>9150 000 901</b>	Mercedes-Benz 352 201 21 01
<b>Mercedes-Benz</b> Unimog (U800/900/1150)	94,5 mm	<b>9150 000 950</b>	Mercedes-Benz 314 200 42 01
<b>Mercedes-Benz</b> Unimog (U900/1000/1150)	94,5 mm	<b>9150 000 957</b>	Mercedes-Benz 353 200 37 01
<b>Renault</b> Magnum, Midliner, Midlum, Premium	95,5 mm	<b>9150 000 903</b>	Renault 5001837288
<b>Renault</b> Magnum E-Tech 400/440/480	120 mm	<b>9150 000 923</b>	Renault 5001863728
<b>Renault</b> Magnum II/III, Premium I/II, Kerax I/II <b>Volvo</b> FH II, FH16, FM9	130 mm	<b>9150 000 908</b>	Renault 7421615952 Volvo 20744939
<b>Renault</b> Magnum II <b>Volvo</b> FH12, FM12, NH12	130 mm	<b>9150 000 915</b>	Renault 7420734268 Volvo 20734268
<b>Renault</b> Midlum, Premium I/II	99,5 mm	<b>9150 000 925</b>	Renault 5010450892
<b>Renault</b> Midlum I, Premium, Puncher	99,5 mm	<b>9150 000 905</b>	Renault 5010553652
<b>Renault</b> Premium, Kerax, Maxter	124 mm	<b>9150 000 926</b>	Renault 50 01 857 427
<b>Renault</b> T-Truck, Magnum II, C- Truck, K-Truck, Kerax II <b>Volvo</b> FH III, FH II, FH16 III, FH16 II, FM III, FM II, FMX II, FMX I	130 mm	<b>9070 048 716</b>	Renault 7421960482 Volvo 20920065
<b>Scania</b> 112, 113, T113	119 mm	<b>9150 000 956</b>	Scania 1314406
<b>Scania</b> 143	120 mm	<b>9150 000 960</b>	Scania 1375838
<b>Scania</b> 144	105 mm	<b>9150 000 946</b>	Scania 1508532
<b>Scania</b> 92, 93, T93	88 mm	<b>9150 000 959</b>	Scania 1377571
<b>Scania</b> 94	88 mm	<b>9150 000 977</b>	Scania 1510490
<b>Scania</b> P, 124, 114	105 mm	<b>9150 000 927</b>	Scania 1896752
<b>Scania</b> R, G, P, 164	112 mm	<b>9150 000 928</b>	Scania 1549482
<b>Scania</b> R, G, P, 164, 144, 124, 114, 94	112 mm	<b>9150 000 929</b>	Scania 1787120
<b>Volvo</b> F10, F12, FL10, FL12, FS10, N10, NL10, NL12	120 mm	<b>9150 000 961</b>	Volvo 1699786
<b>Volvo</b> FH12, FL12	120 mm	<b>9150 000 913</b>	Volvo 8149941
<b>Volvo</b> FH16, F16	132 mm	<b>9150 000 914</b>	Volvo 1543480
<b>Volvo</b> FM7 I, FL6, FL7	117 mm	<b>9150 000 912</b>	Volvo 1675750



This figure corresponds to  
9150 000 970



## Water pump

Scope of supply  
with gaskets

Suitable for	Impeller-∅	Order no	Comparative no
Irisbus Proway	83 mm	9150 000 904	Iveco 504062854
MAN EM, NM, SM	110 mm	9150 000 900	MAN 51.06500-6515
MAN EM, NM, SM	135 mm	9150 000 936	MAN 51.06500-3178
MAN EM, NM, SM	125 mm	9150 000 955	MAN 51.06500-6537
MAN EM 192, NM 182/192, SM 182/192 Neoplan Jetliner/Sportliner (N 208)	125 mm	9150 000 939	MAN 51.06500-6462
MAN Lion's City (A20/A21/A23/A25/A26/A36/A39/A40/A44/A45), Lion's Regio (R12/R13/R14), NG (A23), NL (A21), NÜ (A20) Neoplan Centroliner (N 45XX), Trendliner (N 3516)	135 mm	9150 000 906	MAN 51.06500-6676
MAN Lion's City (A20/A21), NG (A11/A23), NL (A10/A15/A21), NÜ (A20) Neoplan Centroliner (N 44XX)	125 mm	9150 000 943	MAN 51.06500-6480
MAN Lion's City (A21/A26), Lion's Classic Ü (A72), Lion's Coach (R07), Lion's Comfort, Lion's Regio (R12), Lion's Star (R02), NG (A23), NL (A10/A15/A21), NÜ, ÜL Mercedes-Benz Citaro I (O 530), Conecto I (O 345), O 403, O 404, O 405, O 407, Tourismo I (O 350), Travego I (O 580) Neoplan Centroliner (N 44XX/N 45XX), Tourliner (N 2216), Trendliner (N 3516) Setra S 315/319 NF, S 313/315/319 UL, SG 321 UL	135 mm	9150 000 958	MAN 51.06500-6426 Mercedes-Benz 403 201 15 01
MAN Lion's City (A21), EL, NG (A11/A23), NL (A10/A15/A21), NÜ (A20)	125 mm	9150 000 969	MAN 51.06500-6543
MAN Lion's City (A26), Lion's Comfort, NÜ, ÜL	135 mm	9150 000 944	MAN 51.06500-6492
MAN Lion's City (A26), Lion's Comfort Neoplan Centroliner (N 44XX), Transliner (N 316/321)	135 mm	9150 000 947	MAN 51.06500-6492
MAN Lion's City (A37/A78), SÜ 263/273/283/293/313/320/353/360	135 mm	9150 000 933	MAN 51.06500-6680
MAN Lion's Classic Ü (A72), EM, NM, SM	125 mm	9150 000 962	MAN 51.06500-6612
MAN Lion's Coach (R07/R08) Neoplan Cityliner (N 12XX), Skyliner (N 1122/2011-), Starliner (N 52XX), Tourliner (N 2216)	135 mm	9150 000 971	MAN 51.06500-6675
MAN Lion's Coach (RH 353/403), Lion's Star (RH 414/464), NG (A11/A23), NL (A10/A15/A21), SÜ	135 mm	9150 000 935	Mercedes-Benz 403 200 75 01
MAN SÜ 240 Mercedes-Benz Citaro I (O 530), Conecto I (O 345), Integro II (O 550), Intouro I (O 560), O 405 N, O 407, O 408, Tourismo I/II (O 350), Travego I/II (O 580) Neoplan Cityliner (N 122/217), Jetliner (N 216), Megaliner (N 128), Transliner (N 316)	125 mm	9150 000 940	MAN 51.06500-6282 Mercedes-Benz 441 200 01 01
Mercedes-Benz Citaro (O 530), Conecto (O 345), Integro (O 550), Tourino (O 510)	112 mm	9150 000 970	Mercedes-Benz 906 200 65 01
Mercedes-Benz Citaro I/II (O 530), Conecto I (O 345), Integro II (O 550), Intouro I (O 560), O 405 N, O 407, O 408, Tourismo I/II (O 350), Travego I/II (O 580) Setra S 315 UL, S 415 HD, S 417 HDH, S 415/416/417 GT-HD, S 415 NF, S 415/417/419 UL	125 mm	9150 000 973	MAN 51.06501-3143 Mercedes-Benz 457 200 27 01
Mercedes-Benz Citaro I (O 530), Cito (O 520), Conecto I (O 345), Tourino (O 510), Vario (O 810-815)	112 mm	9150 000 967	Mercedes-Benz 904 200 49 01
Mercedes-Benz Citaro I (O 530), Conecto I (O 345), Tourismo I (O 350), Travego I (O 580) Setra S 415/416 GT, S 415/416/417 GT-HD	125 mm	9150 000 909	Mercedes-Benz 457 200 24 01
Mercedes-Benz Citaro I (O 530), Tourismo I (O 350), Travego I (O 580)	125 mm	9150 000 974	Mercedes-Benz 457 200 29 01
Mercedes-Benz O 405, O 407	125 mm	9150 000 942	Mercedes-Benz 403 200 73 01
Mercedes-Benz O 407, O 408	125 mm	9150 000 934	Mercedes-Benz 422 200 13 01
Mercedes-Benz Travego I (O 580)	125 mm	9150 000 972	Mercedes-Benz 542 200 20 01
Mercedes-Benz Travego I (O 580)	125 mm	9072 201 072	Mercedes-Benz 541 200 10 01
Mercedes-Benz Vario (O 810-815)	112 mm	9150 000 921	Mercedes-Benz 904 200 51 01
Neoplan Centroliner	135 mm	9150 000 932	MAN 51.06500-6679
Neoplan Cityliner (N 217), Transliner (N 316)	125 mm	9150 000 938	Mercedes-Benz 403 200 49 01
Scania K114/124, L94	105 mm	9150 000 927	Scania 1896752
Scania K380	112 mm	9150 000 929	Scania 1787120
Van Hool T911	135 mm	9072 201 081	
Volvo B12	130 mm	9150 000 915	Volvo 20734268
Volvo B12, B10R	120 mm	9150 000 961	Volvo 1699786
Volvo B6, B7, B7L, B7R	117 mm	9150 000 912	Volvo 1675750
Volvo B9L, B9R, B9S, B9TL	130 mm	9150 000 908	Volvo 20744939

# Coolant thermostat



This figure corresponds to 1602 900 000



## Coolant thermostat

Scope of supply  
with gasket

Suitable for	Height	Opening temperature	Order no	Comparative no
DAF XF105, XF95 Renault Premium I/II, Kerax Volvo FM7, FM10, FM12, FH12, FH19, FL6, FL10	48 mm	82 °C	1602 900 003	DAF 1684900
Iveco EuroTech MAN TGA, TGL, TGM, F2000, L2000, M2000L/M, F90, M90	25,5 mm	80 °C	1602 900 002	MAN 51.06402-0061
MAN TGX, TGS, TGA, TGM, TGL	25,5 mm	83 °C	1602 900 008	MAN 51.06402-0063
MAN TGX, TGS, TGA, TGM, TGL Mercedes-Benz Actros I/MP2/MP3, Arocs, Axor I/II/III, Atego I/II/III	25,5 mm	83 °C	1602 900 000	Mercedes-Benz 005 203 26 75
Mercedes-Benz Actros I/MP2/MP3, Axor I/II, Atego I/II	25,5 mm	71 °C	1602 900 006	Mercedes-Benz 004 203 84 75
Renault Magnum II, Premium II Volvo FH II	79 mm	82 °C	1602 900 005	Volvo 20560249
Scania R, G, P, 164, 144, 124, 114, 94	42,3 mm	80 °C	1602 900 001	Scania 1745449
Scania R, G, P, 164, 144, 124, 114, 94	25 mm	83 °C	1602 900 007	Scania 1916620

# MAHLE



## Coolant thermostat

Opening temperature 84 °C

Suitable for	Order no	Comparative no
Iveco Stralis I, EuroStar, EuroTech, EuroTrakker, Trakker I	1911 020 579	Iveco 500381350

## Coolant thermostat

Opening temperature 87 °C

Scope of supply  
with sealing ring

Suitable for	Order no	Comparative no
DAF CF85 II	6001 439 845	DAF 1661375

## Cover lid



### Cover lid

Opening pressure 1 bar  
Surface galvanised

Suitable for	Order no	Comparative no
MAN G90	9196 060 001	MAN 81.06110-0020



### Cover lid

Opening pressure 0,7 bar  
Surface galvanised

Suitable for	Order no	Comparative no
Mercedes-Benz O 404, O 405 N, O 407, O 408 Setra S 309/312/315 HD, S 315 HDH/2, S 315/317 HDH/3, S 315 GT, S 315/317/319 GT-HD, S 315/319 NF, S 313/315/319 UL, S 315/319 UL-GT, SG 321 UL, S 411/415 HD, S 415/417 HDH, S 431 DT VDL Bova Futura	9196 050 000	Mercedes-Benz 000 501 46 15

## Coolant hose/ Charge air hose



This figure corresponds to 1602 800 000



### Coolant hose

Material EPDM (ethylene propylene diene rubber)/polyester

Suitable for	Inner $\varnothing$	Order no	Comparative no
DAF CF85, CF75	49 mm	1602 800 011	DAF 1744072
DAF CF85, CF75	60 mm	1602 800 010	DAF 1371353
DAF XF95	26/30 mm	1602 800 002	DAF 1399817
Iveco Stralis	58 mm	1602 800 004	Iveco 41226988
Iveco Stralis	58 mm	1602 800 005	Iveco 41218106
Iveco Stralis	58 mm	1602 800 006	Iveco 41218107
MAN F2000, M2000, L2000	18/59 mm	1602 800 008	MAN 81.96305-0129
MAN F2000, M2000, L2000, F90	18/60 mm	1602 800 014	MAN 81.96305-0088
MAN TGA, F2000	10 mm	1602 800 007	MAN 81.96305-0169
MAN TGX, TGS, TGA, TGL, F2000, M2000, L2000	18 mm	1602 800 013	MAN 81.96301-0896
MAN TGX, TGS, TGA, TGL	17,5 mm	1602 800 018	MAN 81.96305-0200
MAN TGA, TGX	59 mm	1602 800 001	MAN 81.96301-0971
Mercedes-Benz Axor I/II	27 mm	1602 800 026	Mercedes-Benz 940 501 18 82
Renault Premium I/II	55 mm	1602 800 012	Renault 5010514267
Scania R, G, P, T	55 mm	1602 800 022	Scania 1755951
Scania R, G, P, T, 94, 114, 124, 144, 164	55 mm	1602 800 009	Scania 2155439
Scania 94, 114, 124, 144, 164, T94, T114, T124, T144	56 mm	1602 800 000	Scania 1517770



### Coolant hose

Inner  $\varnothing$  60/65 mm

Material EPDM (ethylene propylene diene rubber)/polyester

Suitable for	Order no	Comparative no
Mercedes-Benz CapaCity, Citaro (O 530) LE, Conecto II (O 345), Integro II, Intouro II, Turismo I/II (O 350), ravelo I/II (O 580), O 403	1602 800 024	Mercedes-Benz 001 501 39 82 Mercedes-Benz 628 501 77 82
Setra S 411/415 HD, S 415/416/417 HDH, S 431 DT, S 415/416 GT, S 415/416/417 GT-HD, S 415/416 H, S 412/415/416/417/419 UL		

## Our focus is clearly on quality:

Our extensive quality inspection covers every production step from the raw material to the finished end product.

Our PremiumParts radiator hoses are subject to a series of different test procedures.

## Test equipment



### PVT test machine

Vibration tests under pressure are carried out in this.



### Rheometer

The Rheometer measures the vulcanisation properties of the liquid mass.



### Burst resistance

The tightness values of products with plastic parts is measured by pressing the hoses against several rods.



### Cleanliness test

The cleanliness test checks whether the dirt particle size in the product is within acceptable limits.



### Tensometer

The Tensometer allows the products to be tested for tensile strength and elongation at break during vulcanisation.

To ensure constantly high quality, each hose is inspected again by qualified experts before leaving production and is only released if it meets our high quality standards.

**EUROPART**  
GOOD TO KNOW



## Coolant hose

Version	smooth
Length	2 m
Temperature resistance	up to +125 °C
Colour	black
Material	EPDM
Standard	DBL 6254.11

Inner ø	Wall thickness	Order no
10 mm	4,5 mm	9100 000 410
12 mm	4,5 mm	9100 000 411
15 mm	4,5 mm	9100 000 413
18 mm	4,5 mm	9100 000 415
20 mm	4,5 mm	9100 000 416
22 mm	4,5 mm	9100 000 417
25 mm	4,5 mm	9100 000 418
28 mm	4,5 mm	9100 000 419
30 mm	6 mm	9100 000 420
32 mm	6 mm	9100 000 421
35 mm	6 mm	9100 000 422
38 mm	6 mm	9100 000 423
42 mm	6 mm	9100 000 425
45 mm	6 mm	9100 001 426
50 mm	6 mm	9100 000 427
55 mm	6 mm	9100 000 428
60 mm	6 mm	9100 000 429
65 mm	6 mm	9100 000 430
70 mm	6 mm	9100 000 431



This figure corresponds to 8000 946 382



## Charge air hose

Suitable for	Length	Inner ø	Order no	Comparative no
<b>Mercedes-Benz</b> Actros I/MP2/MP3	210 mm	115 mm	<b>5529 000 180</b>	Mercedes-Benz 002 094 66 82
<b>Mercedes-Benz</b> Axor I/II/III	205 mm	100 mm	<b>8000 946 382</b>	Mercedes-Benz 002 094 63 82
<b>Volvo</b> FH II, FH12 I, FM7 I	148 mm	82 mm	<b>6170 002 116</b>	Volvo 20463924



## Coolant hose

Suitable for	Length	Inner ø	Form	Order no	Comparative no
<b>Iveco</b>	85 mm	48/58 mm	90°	<b>1911 043 417</b>	Iveco 5 0033 3973
<b>Iveco</b>	1000 mm	50 mm	straight	<b>3134 000 016</b>	Iveco 500333973
<b>MAN</b>	145 mm	59 mm		<b>1325 050 135</b>	MAN 81.96305-0135
<b>Mercedes-Benz</b>	104 mm	60 mm	straight	<b>3180 410 093</b>	Mercedes-Benz 942 501 05 82
<b>Mercedes-Benz</b>	1000 mm	60 mm	straight	<b>3134 000 018</b>	Mercedes-Benz 942 501 05 82



# Tools/Workshop requirements



## Thermal imaging camera

Reliable temperature measurement and storage of images and data for reporting, recording of exact data from a safe distance, colour display for secure evaluation and analysis of temperature statuses, with laser cross for exact positioning, three selectable colour palettes for image display: iron, rainbow and grey, storage of the image in bitmap format (BMP) with temperature and emission degree, measuring range can be selected between Celsius °C or Fahrenheit °F, integrated LED lights support work in darker areas, adjustable switch-off mechanism, date and time adjustable for exact data recording, built-in Micro USB port, on/off switch also used to protect the camera, laser cross frames the temperature measurement range, detector with IR-EX™ technology (integrated IR-Array-Sensor with CMOS-Sensor)

Version With UV lamp  
 Measuring range -30 to 650 °C  
 Operating temperature 0 to 50 °C

Precision ±1.5% or 1.5 °C  
 Emission ratio 4 pre-set values, user-specific adaptation possible from ε 0.10 to 1.00  
 Distance to target ratio (D:T) 30:1  
 Measurement resolution 0.1 °C/°F  
 Response time >125 ms  
 Spectral range 8 to 14 μm  
 Resolution 16,384 pixels (128 x 128)  
 Thermal sensitivity 150 mK  
 Refresh rate <9 Hz  
 1.77" TFT colour monitor (128 x 160 pixels)  
 Battery runtime with laser and light 12 hours

### Application range

Ideal for detection of leaks in the cooling or air conditioning system

### Scope of supply

with 2 GB Micro SD storage cards, battery set 3 x AA, sturdy plastic case

Order no

9502 980 328



## Thermometer

with long and narrow measuring shaft, scale with °C and °F classification

Overall length 210 mm  
 Measuring range 0 to +200 °C

### Application range

To control temperature measurement of the air flow at the air ducts, also to control the water temperature

Order no

9501 501 963



## Infrared thermometer

Laser measuring gun for contactless temperature measurement, laser measuring beam with red measuring point, illuminated display, LCD digital display, automatic switch-off function, robust plastic housing

Output power, max. 1 mW(2)  
 Measuring range -50 to +550 °C

°C/°F switchable  
 Emission factor fixed at 0.95

### Application range

Rotating motors, hard-to-reach places, liquid media, live lines on heating, gas and air conditioning systems, cooling systems, hot brake discs and aggressive chemicals

### Scope of supply

With 9 V block battery



Order no

9569 743 040



PREMIUM-WERKZEUGE  
**KS TOOLS**  
PREMIUM TOOLS

## Antifreeze testing agent

for fast and accurate checking of the antifreeze content, also permits a visual inspection for rust and other impurities, can also be used at ambient temperatures of less than 10 °C, easy to read thanks to pendulum display (down to -50 °C/-60 °F), high-quality design, plastic housing

Material Plastic

### Application range

Ethylene glycol water mixtures in radiator circuits for passenger cars, commercial vehicles, etc.

Order no

9505 501 241



PREMIUM-WERKZEUGE  
**KS TOOLS**  
PREMIUM TOOLS

## Refractometer

adjustable eyepiece with rubber eye cushion, with automatic temperature compensation (ATC), can also be used in ambient temperatures below 10 °C, measurement correction function using bimetallic strip, high-quality design, good readability due to sharp dividing lines, recalibration possible

Overall length 160 mm

Material aluminium

### Application range

for rapid and precise testing of the acid content of the battery fluid, of the frost protection content and AdBlue® additives, can also be used for coolant and windscreen washer fluids

### Scope of supply

with calibration screwdriver and pipette, in practical plastic case

Order no

9505 501 285



PREMIUM-WERKZEUGE  
**KS TOOLS**  
PREMIUM TOOLS

## Cooling system test device

for diagnosis of leakages on cooling systems, 7 adapters ≈ 85% coverage in commercial vehicle sector, optimal and secure fit like original cover, pressure gauge with rubber protective cap, metal hand pump and flexible hose with pressure relief valve, sturdy design

Material Special steel

### Application range

Commercial vehicles, construction machinery, agricultural technology, municipal and forestry technology, etc.

### Scope of supply

- Hand pump for cooling system test device, 2.5 bar/36 psi
- Pressure-relief hose for hand pump
- Hose adapter size 1 – M42 x 3, size 2 – M45 x 3, size 3 – M45 x 4, size 4 – M52 x 3, size 5 – M62 x 4, size 6 – M72 x 4
- Bayonet adapter diameter 60 mm

Version

9-piece

Order no

8000 050 110



PREMIUM-WERKZEUGE  
**KS TOOLS**  
PREMIUM TOOLS

## Test adapter for cooling system

for diagnosis of leakages in cooling systems, can be used directly at the radiator or expansion tank, secure fit due to expander function, simply handling, sturdy design made of POM

Height 170 mm

Material Polyoxymethylene

### Application range

Commercial vehicles, construction machinery, agricultural technology, municipal and forestry technology

∅	Order no
17-37 mm	9504 550 141
28-41 mm	9504 550 142
37-50 mm	9504 550 143
47-60 mm	9504 550 144



### Leak test set

for localisation of leaks in combustion engines, efficient and reliable finding of cracks and leaks, evidence of any CO<sub>2</sub> content in the coolant, ideal for use with cylinder heads, cylinder head gaskets and engine blocks, leak visible due to discolouration of the test liquid, self-regenerating reaction fluid for multiple use

**Application range**

For all current vehicles with water-cooled engines (gas, diesel and petrol)

**Scope of supply**

Intake rubber bellows, two-way brass valve, base unit with 2 test chambers and cone, reaction fluid (250 ml), empty container (250 ml), cooling system bayonet adapter #1, #2, #3, sturdy plastic case

Version	Order no
8-piece	9501 501 910



### Water pump tester set

enables effective display of the coolant flow, no removal of the water pump required, test carried out with engine running, time-saving diagnosis

**Scope of supply**

Measuring device (low pressure 0-15 psi), 2-piece blind plug rubber pipe sealing set, 6 mm plastic hose (length 2 m), hose supports with external thread, pipe connector

Version	Order no
8-piece	9501 509 020



### Diagnosis set for cooling systems and heaters

for checking tightness, pressure loss is monitored via a pressure gauge, fast and efficient application

Measuring range 0-2.5 bar

**Application range**

All current vehicles with water-cooled engines

**Scope of supply**

with a sturdy plastic case

Version	Order no
25-piece	3002 432 453



### Fluidstopper

**All in one**

for easy sealing of pipes of 4.75 mm (3/16") to 14.0 mm (9/16"), rotary magazine with 4 supports for the corresponding pipe size, protects against penetration of moisture and foreign bodies

∅ 4,75-14 mm

Overall length 120 mm

**Application range**

Suitable for maintenance work with petrol, oil, water and radiator antifreeze in passenger cars, vans, commercial vehicles and industrial applications

**Scope of supply**

Set of 2

Version	Order no
	8000 021 295



PREMIUM-WERKZEUGE  
**KS TOOLS**  
PREMIUM TOOLS

## Hose clamp set

Infinitely variable flow regulation, sensitive flow regulation or complete flow stopping, avoidance of hose damage through wide-area squeezing of the hose against the sturdy steel hook, with swivelling metal clamp wing, protects against spillage of petrol, oil, water and radiator antifreeze

Temperature resistance 160 °C  
Material Special steel

### Application range

For easy disconnection of flexible hose lines of 10 mm (3/8") to 45 mm (1,3/4")

### Scope of supply

With 1 x hose clamp max. diameter 10 mm (3/8"), 1 x max. diameter 15 mm (1/2"), 1 x max. diameter 25 mm (1"), 1 x max. diameter 45 mm (1 3/4")

Version	Order no
4-piece	6974 221 200



PREMIUM-WERKZEUGE  
**KS TOOLS**  
PREMIUM TOOLS

## Disconnecting pliers set

for complete stopping of the flow, wide area of the hose is squeezed against the contact surface, preventing damage to the hose, protects against spillage of petrol, oil, water and radiator antifreeze, lockable with latching function

Overall length 150 mm  
Hose outer dia. 15 mm  
Temperature resistance 160 °C  
Material Plastic

### Application range

For easy disconnection of flexible hose lines from 15.9 mm (5/8") to 60 mm (2.3/8"), ideal for maintenance work with petrol, oil, water and radiator antifreeze

Version	Order no
3-piece	8000 155 050



PREMIUM-WERKZEUGE  
**KS TOOLS**  
PREMIUM TOOLS

## Disconnecting pliers set

Angled, adjustable locking ring with latching function, ideal for maintenance work with petrol, oil, water and radiator antifreeze, protects against spillage of petrol, oil, water and radiator antifreeze

Suitable for hoses from 15 mm to 60 mm  
Material Plastic  
Temperature resistance 160 °C

### Application range

Ideal for commercial vehicles, vans, passenger cars, tractors, agricultural and construction machinery and industrial applications

Version	Order no
3-piece	9501 155 055

# EUROPART® – a strong brand name

In addition to well-known manufacturers' branded products, EUROPART also offers a comprehensive Premium Parts Programme with 7,000 articles from the different EUROPART product ranges.

### Your advantages:

- Highest quality standards
- Maximum availability at 300 locations in 28 countries
- Increasing your competitiveness
- Consistent service package



**EUROPART**  
**GOOD TO KNOW**



**Assortment case  
OETIKER 1 ear clamp**

**Scope of supply**  
120 pieces, assorted  
Infinitely variable, stainless steel, dimensions: 5.8 x 7 to 14.5 x 17

Order no

9500 449 221



**Assortment case  
NORMA hose clamps**

**Scope of supply**  
150 items, assorted:  
band and body of stainless steel, dimensions: 8-12 to 32-50

Order no

9500 449 165



**Assortment case  
NORMA/COBRA hose clamps**

**Scope of supply**  
180 pieces, assorted  
Stainless steel, dimensions: 7.5/7 to 21.0/8

Order no

9500 449 213



## Socket screwdriver ERGOTORQUE®

Flexibly limited torque, double spiral spring, plastic-coated, with hanging hole

Material Chrome-vanadium steel

Spanner size	∅	Order no
7 mm	11,7 mm	0959 111 127
8 mm	11,9 mm	9509 111 128
10 mm	12,5 mm	9509 111 125



## Hose clip pliers

Version	with locking mechanism, length adjustable double Bowden cable and dip-insulated handle
Bowden cable length	600 mm
∅	0-70 mm
Form	straight
Material	Special tool steel

### Application range

For self-tensioning, hard-to-reach spring band clamps

Order no  
9501 151 065



## Hose clip pliers

internal spring

Version	with locking mechanism, dip-insulated handle
Bowden cable length	650 mm
∅	0-60 mm
Form	straight
Material	Chrome molybdenum steel

### Application range

For self-tensioning, hard-to-reach spring band clamps

Order no  
3002 423 834



## Hose clip pliers

internal spring

Version	with latching function, locking mechanism and release lever, dip-insulated handle
Bowden cable length	650 mm
Material	Chrome molybdenum steel

### Application range

For self-tensioning, hard-to-reach spring band clamps

Order no  
9501 151 168



## Hose clip pliers

with reinforced Bowden cable, internal spring, reduced torsion of the pliers with strong clamps, with quick-change system for replacement Bowden cable

Version	with locking mechanism, 2-part handle
Bowden cable length	590 mm
∅	15-54 mm
Form	straight
Material	Hardened steel

### Application range

Ideal for opening and closing hose clamps, suitable for hard-to-reach self-tensioning spring band clamps

Order no  
9501 150 901





### Hose clip pliers

Semi-rigid, plastic-coated gooseneck, easy one-handed operation in deep areas, clamp secured with microtoothing, working head with raised grippers and wide recess

Version with 2-part handle  
 Bowden cable length 660 mm  
 Material Chrome molybdenum steel

**Application range**

for actuation of self-tensioning spring band clamps, for cooling or heating systems, ideal for cramped places

**Order no**  
3002 432 776



### Hose clip pliers

Version infinitely variable locking mechanism, with quick-release lever  
 Bowden cable length 600 mm  
 Material Special tool steel

**Application range**

Proper assembly and disassembly for hard-to-reach spring band clamps

**Order no**  
9501 151 189



### Hose clip pliers

Version self-opening, dip-insulate handle  
 Length 160 mm  
 Cheek length 40 mm  
 Ø 0-60 mm  
 Form straight  
 Material Chrome molybdenum steel  
 Surface Chrome-plated

**Application range**

For opening and closing click hose clamps, for self-tensioning spring band clamps

**Order no**  
3002 431 474



### Hose clamp

Rotating prism holder, self-opening

Clamping range 8-18 mm  
 Material Special steel  
 Surface Nickel plated

**Application range**

for proper assembly and disassembly of Click, Click R and Cobra clamps, also suitable for self-tensioning hose clamps with flat 3-clamp ends, in particular for fuel lines, coolant and washing water hoses

**Order no**  
9501 151 188



PREMIUM-WERKZEUGE  
**KS TOOLS**  
PREMIUM TOOLS

### Click hose clamp pliers

Fuel-saving opening and closing, forged bite jaws

Form 90° angled  
Overall length 180 mm  
Material Special steel

Jaw size A 0-18 mm

#### Application range

For proper assembly and disassembly of Click, Click R and Cobra clamps, also suitable for self-tensioning hose clamps with flat 3-clamp ends

Order no

9501 151 179



PREMIUM-WERKZEUGE  
**KS TOOLS**  
PREMIUM TOOLS

### Click hose clamp pliers

reusable V2A clamp

Version self-opening, lockable, with dip-insulated handle, forged  
Jaw size 0-38 mm  
Overall length 180 mm  
Cheek length 25 mm  
Material Molybdenum steel  
Surface Chrome-plated

#### Application range

For opening and closing Cobra hose clamps

Order no

3002 431 479



PREMIUM-WERKZEUGE  
**KS TOOLS**  
PREMIUM TOOLS

### Hose release pliers

Securing screw for adjusting jaws, gentle on materials, simple operation, lower power usage, plastic handle

∅ 15-54 mm  
Length 180 mm  
Material Special steel

#### Application range

suitable for releasing secured cooling hoses

Order no

9501 151 199



PREMIUM-WERKZEUGE  
**KS TOOLS**  
PREMIUM TOOLS

### Chain gaspipe pliers

with release lever, locking mechanism, size adjustment through adjusting wheel, good adaptation to available contact surfaces, no widening under heaviest loads, release lever under constant spring pressure

∅ 150 mm  
Overall length 220 mm  
Chain length 460 mm  
Material Chrome molybdenum steel  
Surface Nickel plated

#### Application range

For securing and tensioning different profiles, ideal for cramped conditions

Order no

9501 151 171



PREMIUM-WERKZEUGE



### Special socket wrench set

Drive 3/8"  
 Drive form hexagon  
 Form open  
 Material Chrome-vanadium steel  
 Surface matt satin chrome-plated

**Application range**

For assembly of temperature sensors, thermostats and other components wired from above and from the side, also suitable for screw-on connections of angled pipelines

**Scope of supply**

Special socket wrench 10/11/12/14/17/19 mm

Version	Order no
6-piece	9501 503 805



PREMIUM-WERKZEUGE



### Oil pan

with four carry handles, 11 cm tall extra flat edge, safe and neat pouring through circumferentially overflow border and spout, handy, quick and environmentally friendly, impact-resistant, oil and chemical-resistant

Volume 55 l  
 Length 1030 mm  
 Width 724 mm  
 Height 110 mm  
 Material Polyethylene

**Application range**

Oil, chemicals, petrol, acids and antifreeze, also suitable for cleaning parts

Order no
9501 509 358



### Coolant can made of polyethylene

with cap and filter

Capacity 11 l  
 Colour black

Order no
2300 061 353



### mato

#### Funnel

Version with filter  
 Ø 160 mm  
 Material Polyethylene

Order no
9516 351 618

PREMIUM-WERKZEUGE



### Measuring beaker

Flexible hopper-shaped outlet enables neat drainage, break-proof, stable, graduation, with handy carry-handle, oil and chemical-resistant

Capacity 2 l  
 Material Special plastic

**Application range**

Oil, chemicals, petrol, acids, antifreeze and non-acid containing liquids



Order no
9501 509 235



## Suction and filling hand pump

Precisely adjustable, excess material can be sucked back easily, sturdy design

Volume	1,5 l
Hose outer dia.	16 mm
Hose inner-Ø	14 mm
Hose length	320 mm
Housing length	320 mm
Material	Polypropylene

### Application range

For filling, draining or metering liquids in gearboxes, engines, power steering, hydraulics, motors, etc., suitable for petrol, oil, antifreeze and water

### Scope of supply

Rubber hose with delivery stop cap

Order no

9501 509 222



## Mini transfer pump

Hoses are mounted on the transfer pump using the hose clamps supplied

Hose inner-Ø	8 mm
Hose length	2 x 900 mm
Material	PVC

### Application range

Ideal for topping up in emergencies, suitable for battery acid, fuels, oils and distilled water

Order no

9501 501 665



## Filling fitting

Large throughput guarantees fast drainage, quick connection made of stainless steel

Outer Ø	15 mm
Inner-Ø, min.	9,8 mm
Length	78 mm

### Application range

For replacing coolant in Scania 340/360 trucks and buses as well as Renault/Volvo

Order no

8000 050 076



## Cooling system vacuum filling unit

with supporting chain for hanging up

### Application range

For filling and checking the tightness of the cooling system

### Scope of supply

Including valves, connections and dial gauge

Order no

9501 501 960



### Radiator cleaner

Contents	Container	Order no
300 ml	Can	9898 700 166



### Radiator cleaner

#### Liqui Moly Pro Line

Chemically dissolves existing deposits of lime scale in the complete heating and cooling circuit without leaving any residue. Eliminates for example scale and other deposits, does not contain any aggressive acids or alkalis, also therefore does not attack rubber or plastics.

Contents	Container	Order no
1 l	Can	9773 005 189

The quality of radiator frost protection drops continually especially for the care and protection additives used, and problems increasingly occur, in the worst case even unexpected failures and subsequent high costs.

From about 60 °C, the lime in the water can "fall out" in both the heating and the cooling circuits, this can then lodge on the thermostat valves, lines and pipes and thus seriously affect the function of the whole cooling and heating circuit. This can even lead to complete replacement of the "scaled" components and increase the risk of your vehicles failing.

Buses especially often have problems here, with their large heating circuits for the passenger compartment and the driver's position - reduced heating power and valves which are difficult to move are often the first indication which should be taken seriously to avoid subsequent high costs.

**EUROPART**  
**GOOD TO KNOW**



## Radiator protection

### EP 12

Additive for the radiator, contains no nitrites, amines or phosphates and is **silicate-free**, protects the radiator from frost and corrosion, raises the boiling point of water, can only be mixed with other G11 and G12 radiator antifreeze agents of the same quality, can be used in MB 325.3, MAN 324 SNF, DAF 74002, VW TL 774 F, MTU MTL 5048, Porsche manufactured from 1996 to 2010, suitable for aluminium engines, based on 1,2-ethanediol (monoethylene glycol)

Contents	Container	Order no
1.5 l	Bottle	9198 544 166
5 l	Canister	9198 544 168
20 l	Canister	9230 003 102
60 l	Drum	<sup>1</sup> 9230 001 101
200 l	Drum	<sup>2</sup> 9230 002 102

<sup>1</sup> incl. drain tap

<sup>2</sup> 2" barrel pump connection



## Radiator protection

### Universal

nitrate, amine, and phosphate free additive for the radiator, protects radiator from frost, corrosion and increases the boiling point of water, DEKRA approved: highly recommended, suitable for cast iron- and aluminium engines, specification BS 6580: 1992, ASTM D 3306

Contents	Container	Order no
1.5 l	Bottle	9230 002 010
5 l	Canister	9230 004 001
20 l	Canister	9230 003 002
60 l	Drum	<sup>1</sup> 9230 001 001
200 l	Drum	<sup>2</sup> 9230 002 002

<sup>1</sup> incl. drain tap

<sup>2</sup> 2" barrel pump connection



## Radiator protection

### EP 40

nitrite, amine and phosphate free, based on ethylene glycol (ethanediol, monoethylene glycol) with a silicon additive package, protects against frost, corrosion and overheating, effectively protects against corrosion and deposits in the cooling system with its main components such as the cooling ducts in the cylinder head, engine block, radiator and water pump, suitable for: VW TL 774 version G (Audi, Bentley, Lamborghini, Seat, Skoda, VW from production year 2008), MB approved 325.5 and 325.6, MAN 324 type Si-OAT, Porsche from production year 1997, MAN from production year 2012, Mercedes-Benz from production year 2012

#### Application range

all modern engines, especially highly stressed aluminium engines

Contents	Container	Order no
1.5 l	Bottle	9198 544 212
20 l	Canister	9198 544 213
60 l	Drum	9198 544 214
208 l	Drum	9198 544 215



## Radiator protection

### EP 48

nitrite, amine and phosphate free, based on ethylene glycol (ethanediol, monoethylene glycol) with a hybrid inhibitor package, protects against frost, corrosion and overheating, effectively protects against corrosion and deposits in the cooling system with its main components such as the cooling ducts in the cylinder head, engine block, radiator and water pump, suitable for: MAN 324 type NF, MB 325.0, VW TL 774 version C, Deutz TR 0199-99-1115/7DE, BMW N 600 69.0, Jenbacher TA-No. 1000-0201, Liebherr Machines Bulle TLV 035, TLV 23009A, MTU MTL 5048.

Contents	Container	Order no
20 l	Canister	9198 836 020
60 l	Drum	9198 836 060
208 l	Drum	9198 836 208





### Drain tap

Suitable for	Fig.	Order no
20 and 60 liter containers	1	9198 544 160
200 litre container	2	9198 544 162



### Electric pump WX40

**Application range**  
for Diesel, Biodiesel, heating oil and cool antifreeze

**Scope of supply**  
including suction hose with filter, anti-kink spring, dispensing valve and lifting protection

**Not suitable for cold pressed rapeseed oil**

Order no
9539 528 009



### Chemical hand pump

#### SRL 885

two-part suction pipe, vertically adjustable through barrel screw attachment

Rate of delivery	approx. 20 l/min
Drum thread	G 2"
Length of suction pipe	885 mm
Hose length	1500 mm

**Application range**

Tank for 60/200/220 l,  
for anti-freeze, glass cleaner, light acids, lyes, soaps, universal thinner (pure or diluted with water)

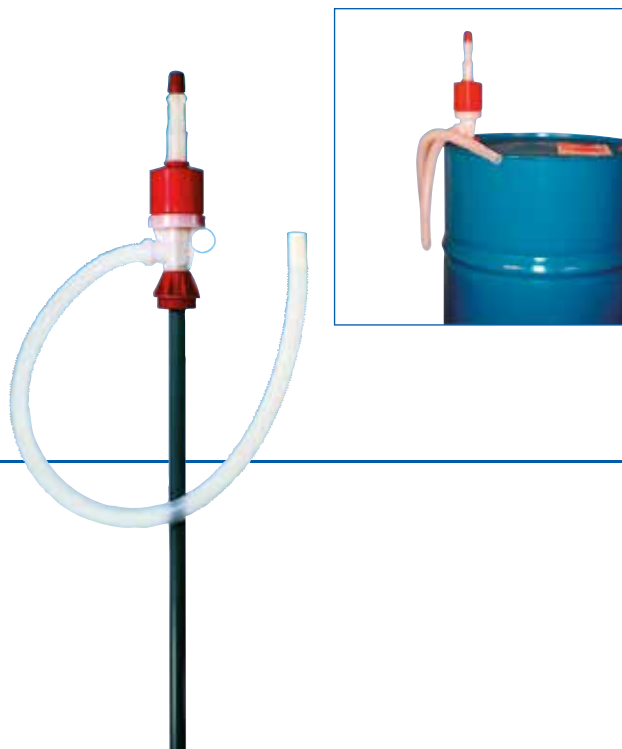

Order no
9522 400 004

# Overview of typical damage

## Water pumps

### Leak



#### Damage

Corrosion due to incorrect coolant mixture ratio (not according to manufacturer's specifications)

#### How to prevent

- Observe manufacturer's specifications
- Rinse the coolant circuit thoroughly
- Only use coolant approved by the manufacturer
- Check coolant regularly and observe the manufacturer's replacement recommendations



#### Damage

Cavitation due to incorrect coolant mixture ratio (not according to manufacturer's specifications)

#### How to prevent

- Observe manufacturer's specifications
- Bleed the coolant circuit
- Only use coolant approved by the manufacturer
- Never mix different coolants
- Check coolant regularly and observe the manufacturer's replacement recommendations



#### Damage

Contamination particles in coolant circuit due to inadequate rinsing

#### How to prevent

- Rinse coolant circuit completely
- Observe manufacturer's specifications
- Only use coolant approved by the manufacturer



#### Damage

Inadequate filling/bleeding of the coolant circuit

#### How to prevent

- Bleed coolant circuit completely
- Observe the manufacturer's specifications



#### Damage

Improper use of sealant

#### How to prevent

- Only use sealant in moderation
- Remove excess sealant
- Observe the manufacturer's specifications

## Water pumps

### Bearing damage



#### Damage

Bearing damage due to leakage

#### How to prevent

- Observe manufacturer's specifications
- Rinse the coolant circuit thoroughly
- Only used coolant approved by the manufacturer
- Check coolant regularly and observe the manufacturer's replacement recommendations



#### Damage

Incorrect belt tension

#### How to prevent

- Check fan belt and replace if necessary
- Check belt tensioner and replace if necessary
- Observe the manufacturer's specifications and replacement intervals



#### Damage

Fault attachment parts (e.g. fault belt pulley/fan)

#### How to prevent

- Check attachment parts before installation of the water pump and replace if necessary
- Observe the manufacturer's specifications and replacement intervals

### Damage on housing



#### Damage

Damage during storage/transport of the product

#### How to prevent

- Handle product with care.
- Protect against falling
- Check for visible damage before installation



#### Damage

Improper installation (e.g. twisted installation results in formation of cracks)

#### How to prevent

- Observe the manufacturer's installation instructions
- Execute steps in accordance with manufacturer's specifications

## Coolant hoses



**Damage**  
Crank in folded area

**Cause**  
Falling below the permissible bending radius during assembly

**Impact**  
Low performance for pressure requirement



**Damage**  
Crack in edge area

**Cause**  
Error during assembly of the radiator hose to the radiator nozzle

**Impact**  
Possible leaking of the radiator hose

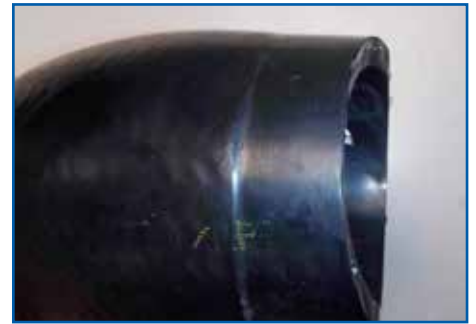

**Damage**  
Irregular shape in edge area

**Cause**  
Improper shortening of the radiator hose

**Impact**  
Inadequate clamping area during assembly



**Damage**  
Incorrect positioning of the hose clamps

**Cause**  
Incorrect alignment during assembly of the clamps

**Impact**  
Incorrect alignment/insecure seating of the hose clamps during assembly



**Damage**  
Surface damage

**Cause**  
Improper handling during insertion, transport or storage

**Impact**  
Leakage between the fitted components



**Damage**  
Damaged connector

**Cause**  
Production error, improper handling

**Impact**  
Incomplete assembly, possible leakage

# **EUROPART – international partner for the workshop**

**300 locations in 28 countries**

Find your nearest EUROPART sales outlet at:  
**[www.europart.net](http://www.europart.net)**

